

Please read this user's guide carefully before installation and keep it for future reference.

Instruction Manual

Product features

- structure greatly shorten the packing space and save the freight ;
- A6063 die-casting aluminum radiator, with air duct design principle of both inside and outside ventilation, and better heat dissipation performance ;
- Waterproof Ip65;
- Use high quality LED and power supply, to ensure the product reliability and life expectancy ;
- Multiple-choices brand LED and power supply ;
- More cost-effective than similar products to meet customers various needs.

Dimension

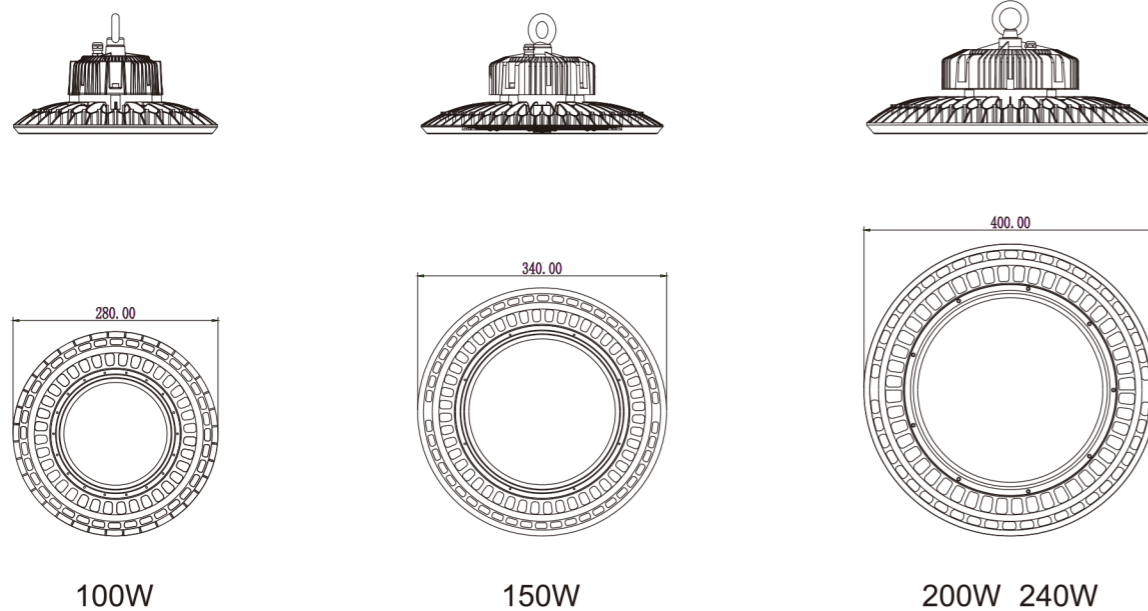

Product Application Instructions

- Installation Methods: Screw Lifting, Hanging chain, Bracket. All accessories will be provided according to customers requirements
- Optimum installation height : 8-15 meters.
- Waterproof IP65.

Please read this user's guide carefully before installation and keep it for future reference.

Installation Instructions

Install with Iron Chain

Step 1: Screw the chain in to the lamp

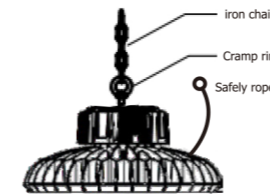

Step 2: Connect the wire

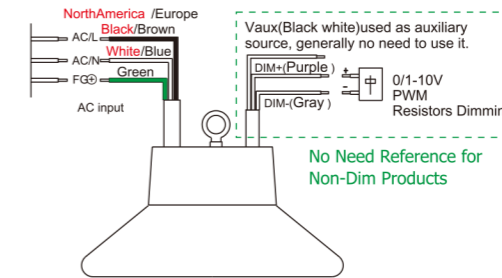

Step 3: Hang up the Iron chain and the ring to the hook.

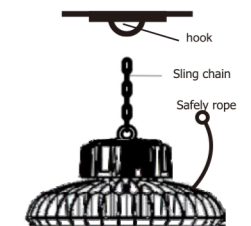

Bracket installation Figure :

Step 1 : Install the bracket

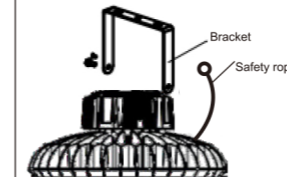

Step 2: Connect the wire

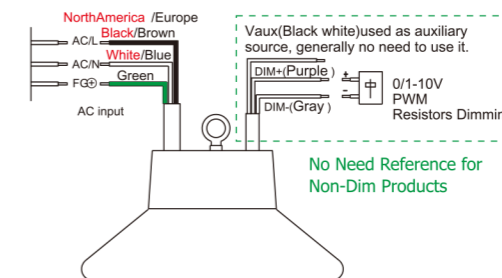

Step 3 : Mounting bracket to the ceiling .

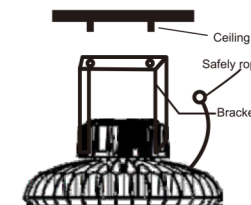

Beam angle can adjustable by bracket :
30° ,60° ,90° ,120° ,150°

Boom installation Figure :

Step 1 : Install the boom to the ceiling

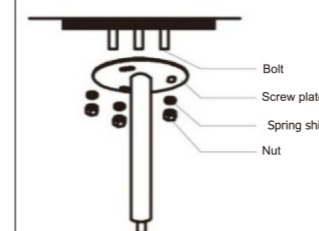

Step 2: Connect the wire

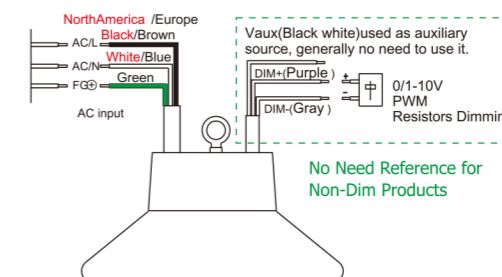

Step 3: Tightening the boom and the lamp

